

ELENA 3D

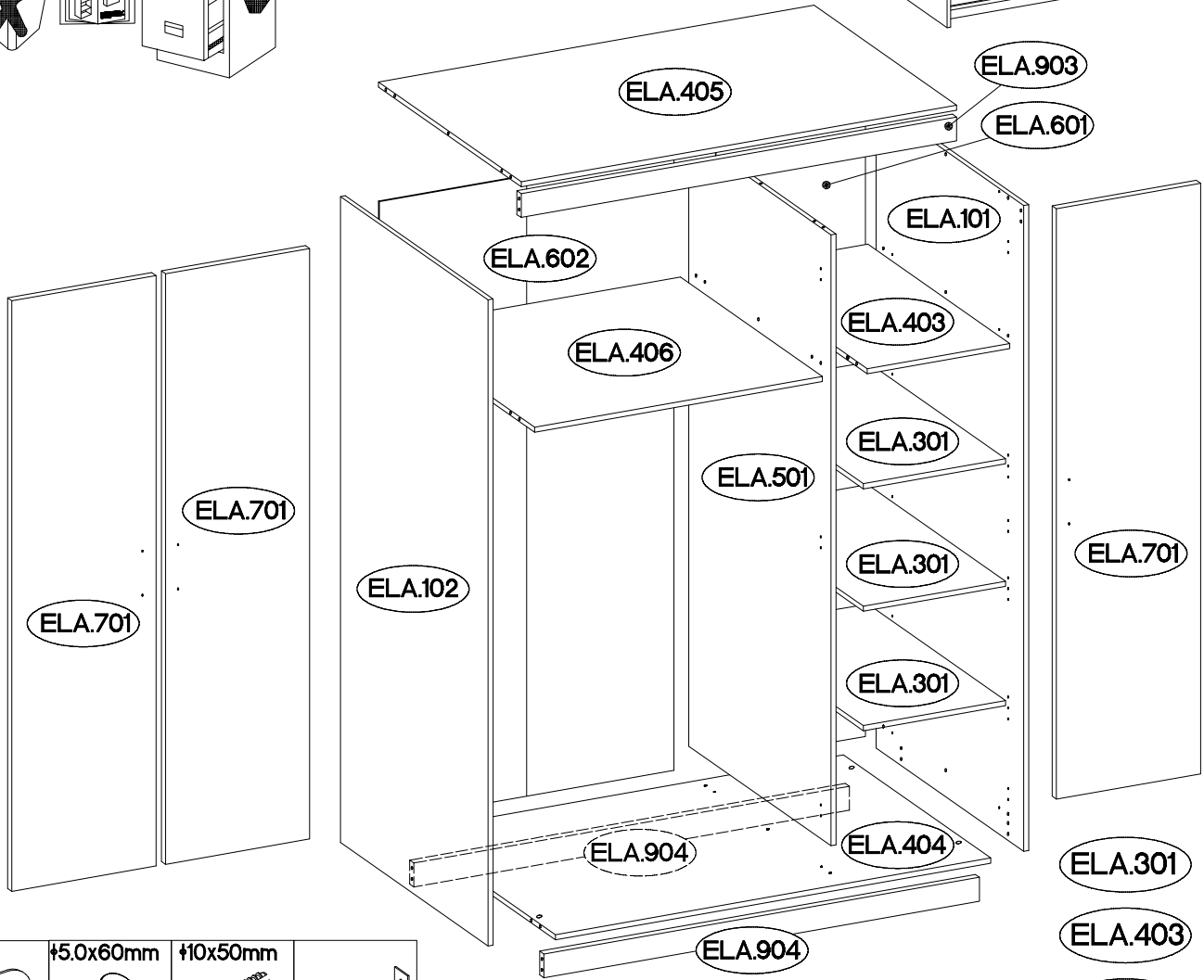

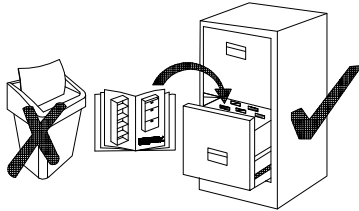

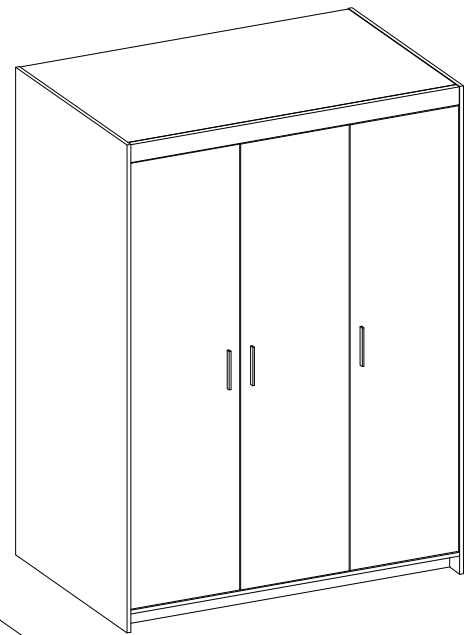

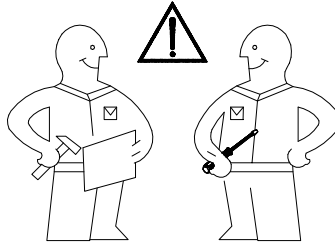
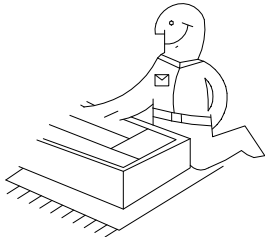
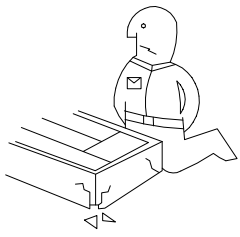



ELA.301
 ELA.403 = max. 5kg
 ELA.406

| | | | |
|----|------------------|----------------|---|
| | +5.0x60mm P12 | +10x50mm O7 | |
| 14 | 1 | 1 | 1 |

| | | | | | | | | | | |
|----------------|----------|-----------------|--------------|-----------------|-----------------|-----------------|---------------|---------------|-----------------|----|
| +35/16mm G2 | H=0 H | +3.5x13mm P5 | L=56mm D4 | 6.5x48x16 F2 | L=85mm J2 | | J3 | +35/9mm G1 | +4.0x16mm P1 | T3 |
| 6 | 9 | 22 | 2 | 4 | 1 | 2 | 12 | 3 | 4 | 2 |
| +15/12mm C | E | +8x30mm A | L=20mm D2 | L=128mm S11 | +4.0x27mm R1 | +3.0x20mm P7 | +15x5mm F4 | | | |
| 20 | 20 | 42 | 16 | 3 | 6 | 66 | 2 | | | |

P-ISM-ELA-02

1

| | | | | | | | |
|--|--|---|--|---|---|---|---|
| L=56mm  | ∅15/12mm  | ∅8x30mm  | L=20mm  | ∅15x5mm  | ∅4.0x16mm  |  | 6.5x48x16  |
| D4 | C | A | D2 | F4 | P1 | T3 | F2 |
| 2 | 20 | 42 | 16 | 2 | 2 | 2 | 4 |

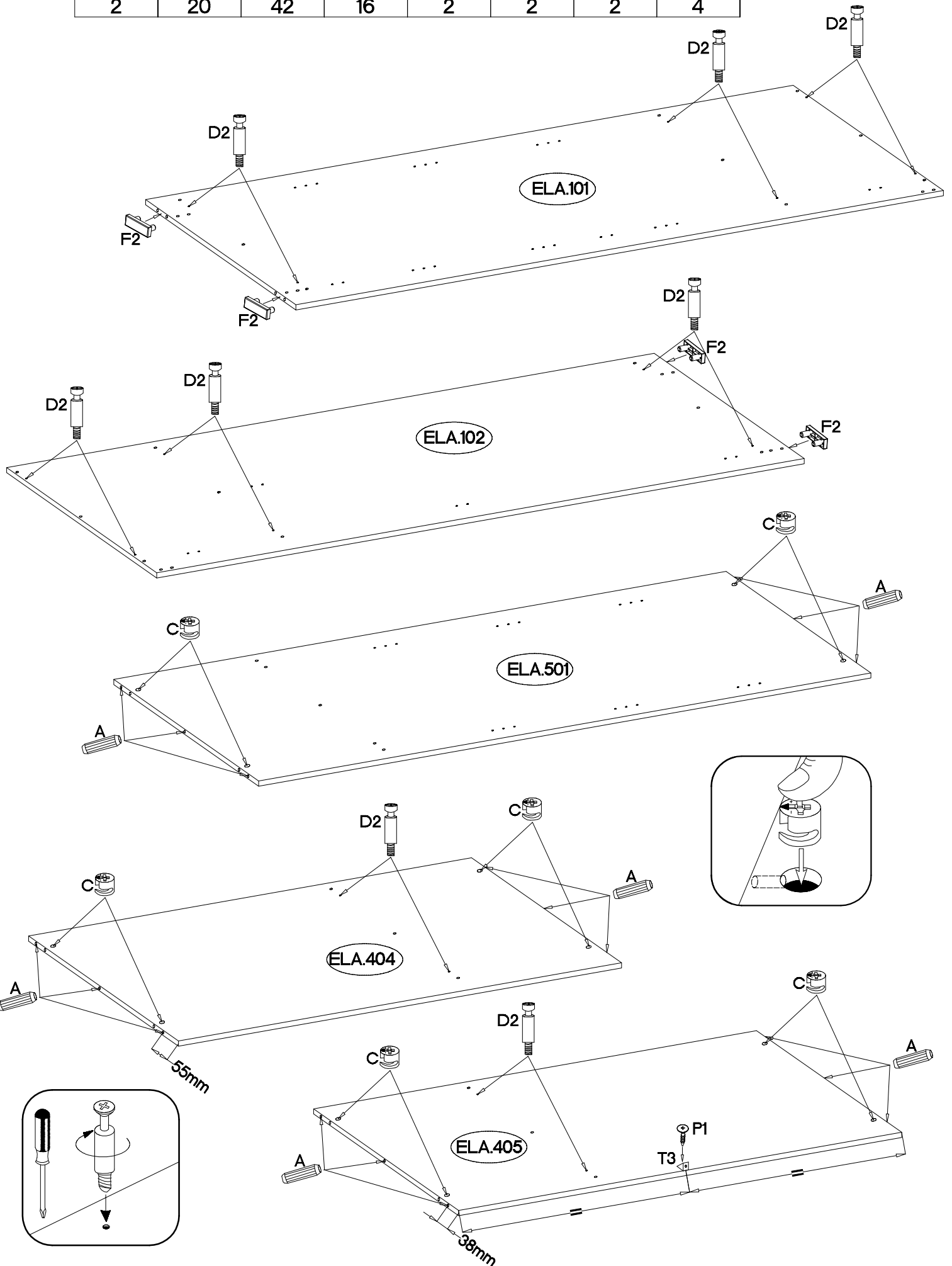

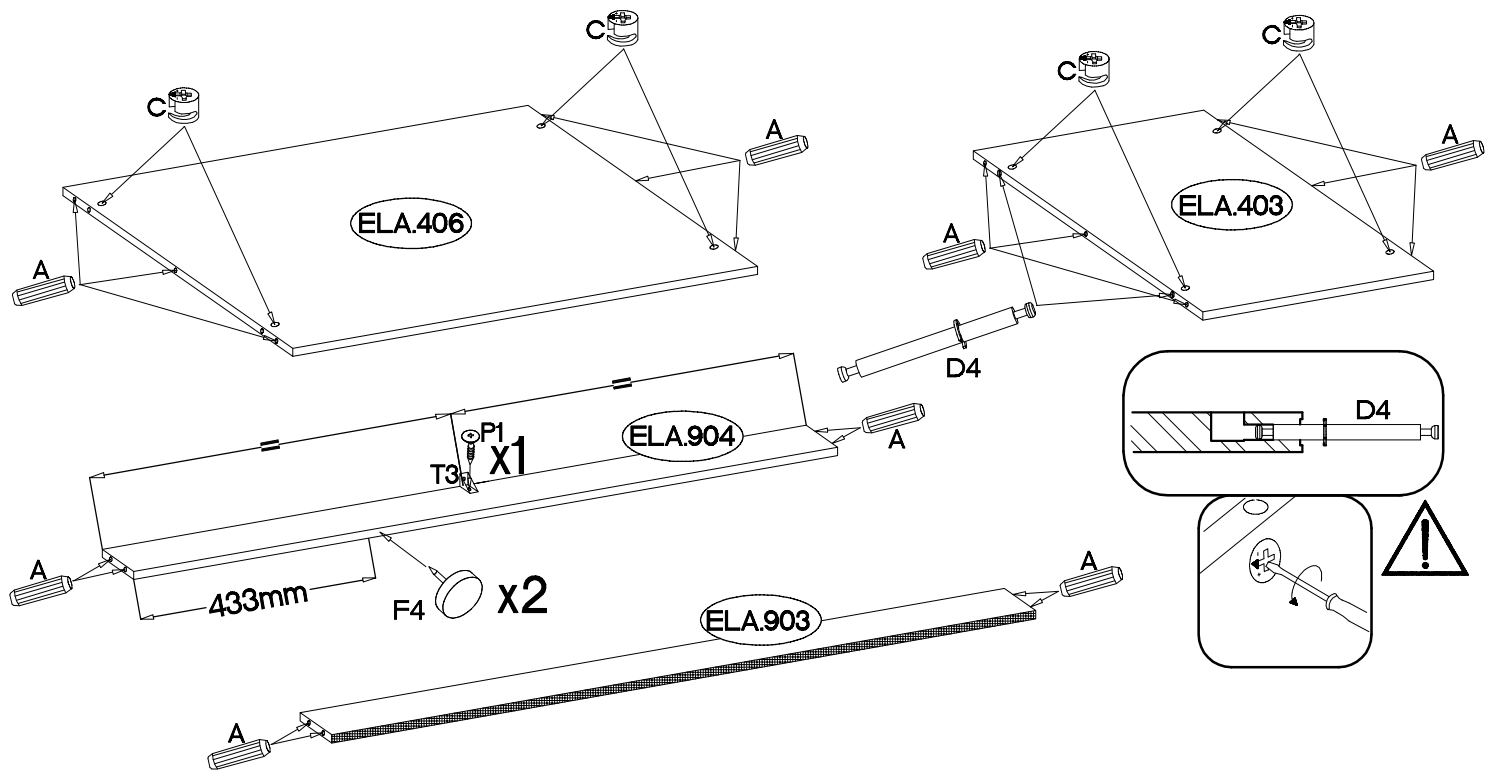

2

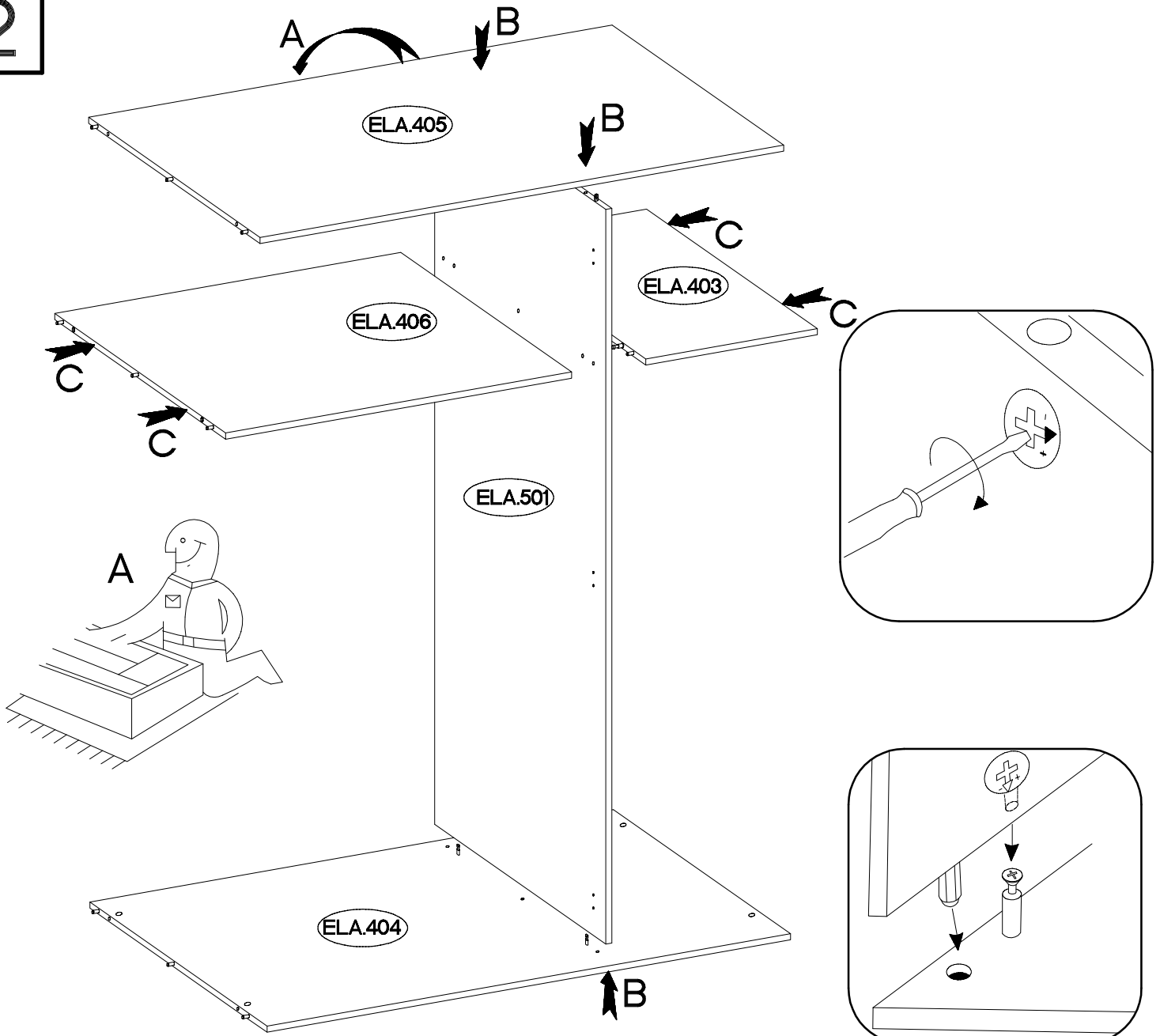

3

4.0x16mm



P1

2



ELA.903

ELA.101

ELA.102

ELA.904

ELA.904

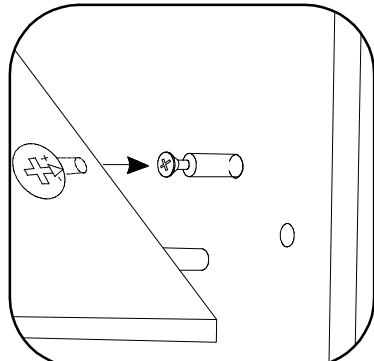
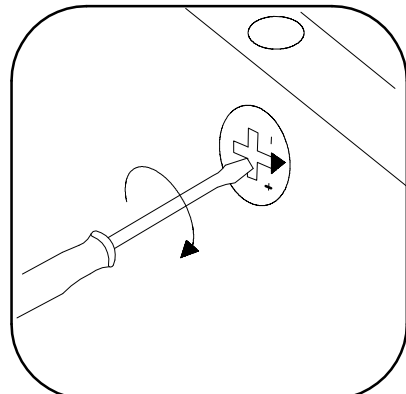
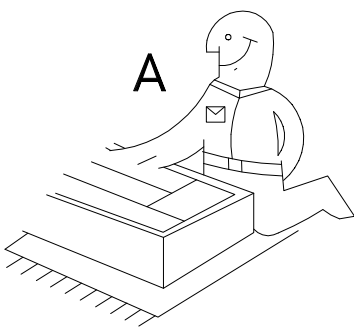
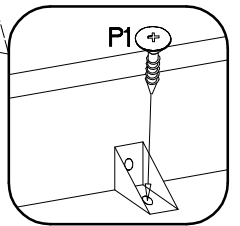

4



| | |
|----|-----------|
| | ±3.0x20mm |
| L2 | P7 |
| 14 | 66 |

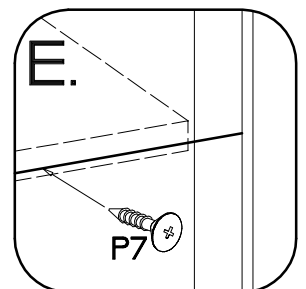
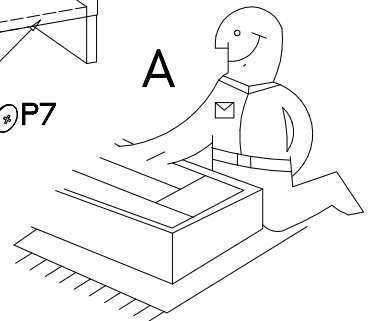
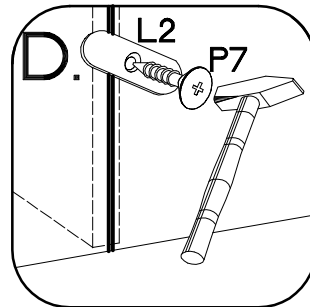
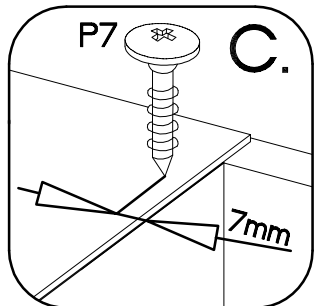
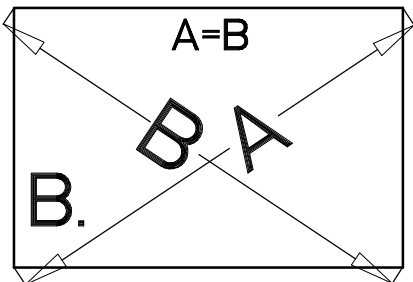
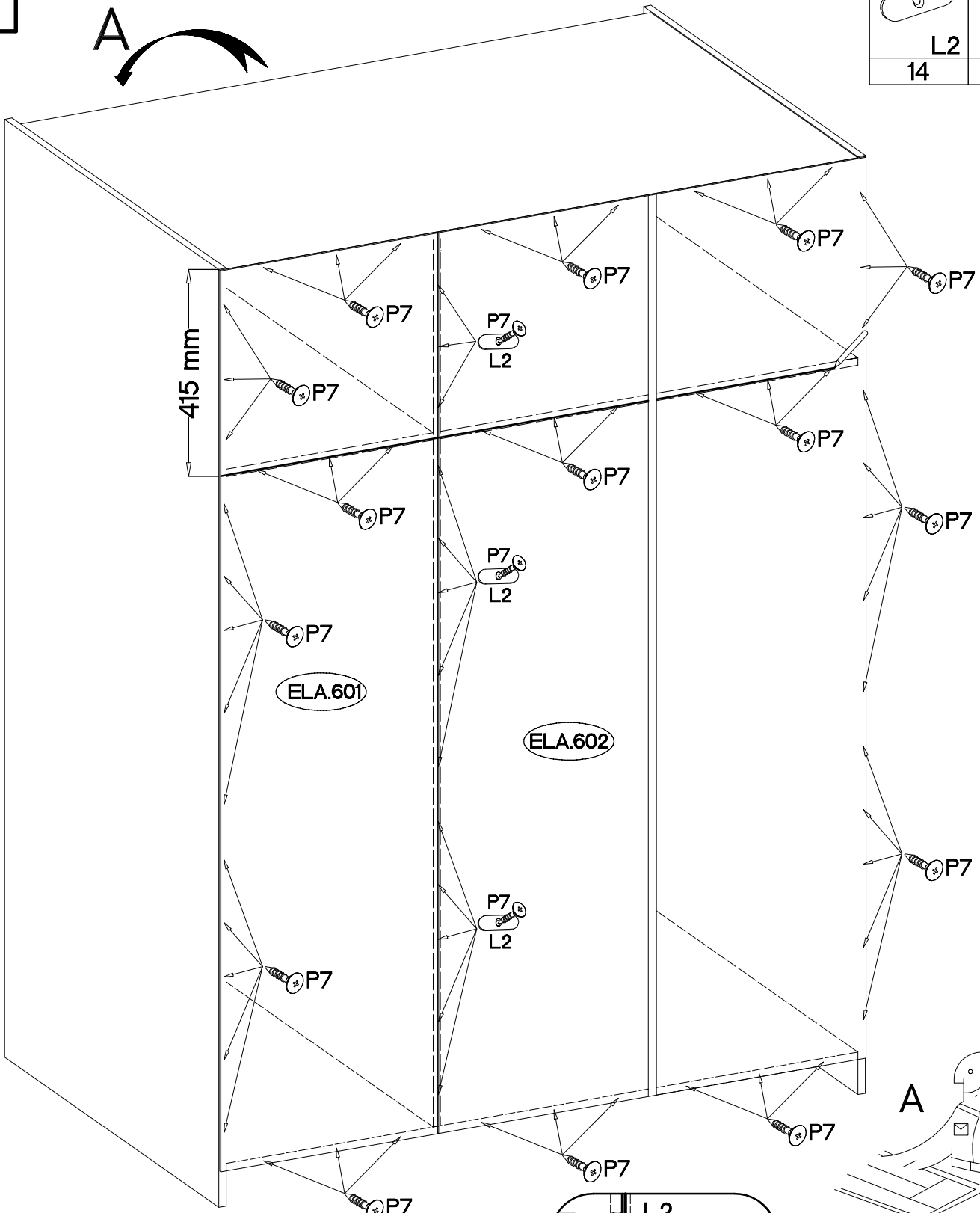



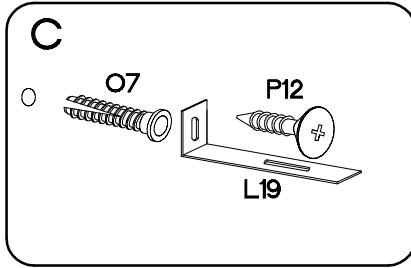
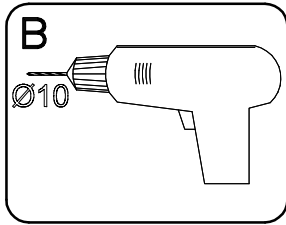

5

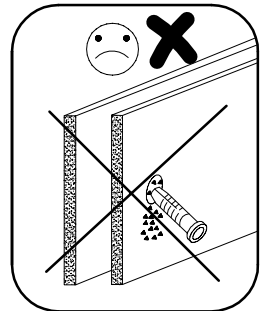
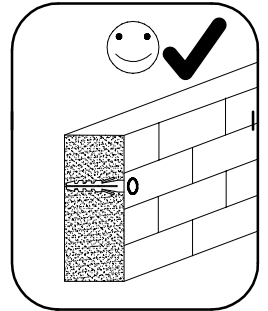
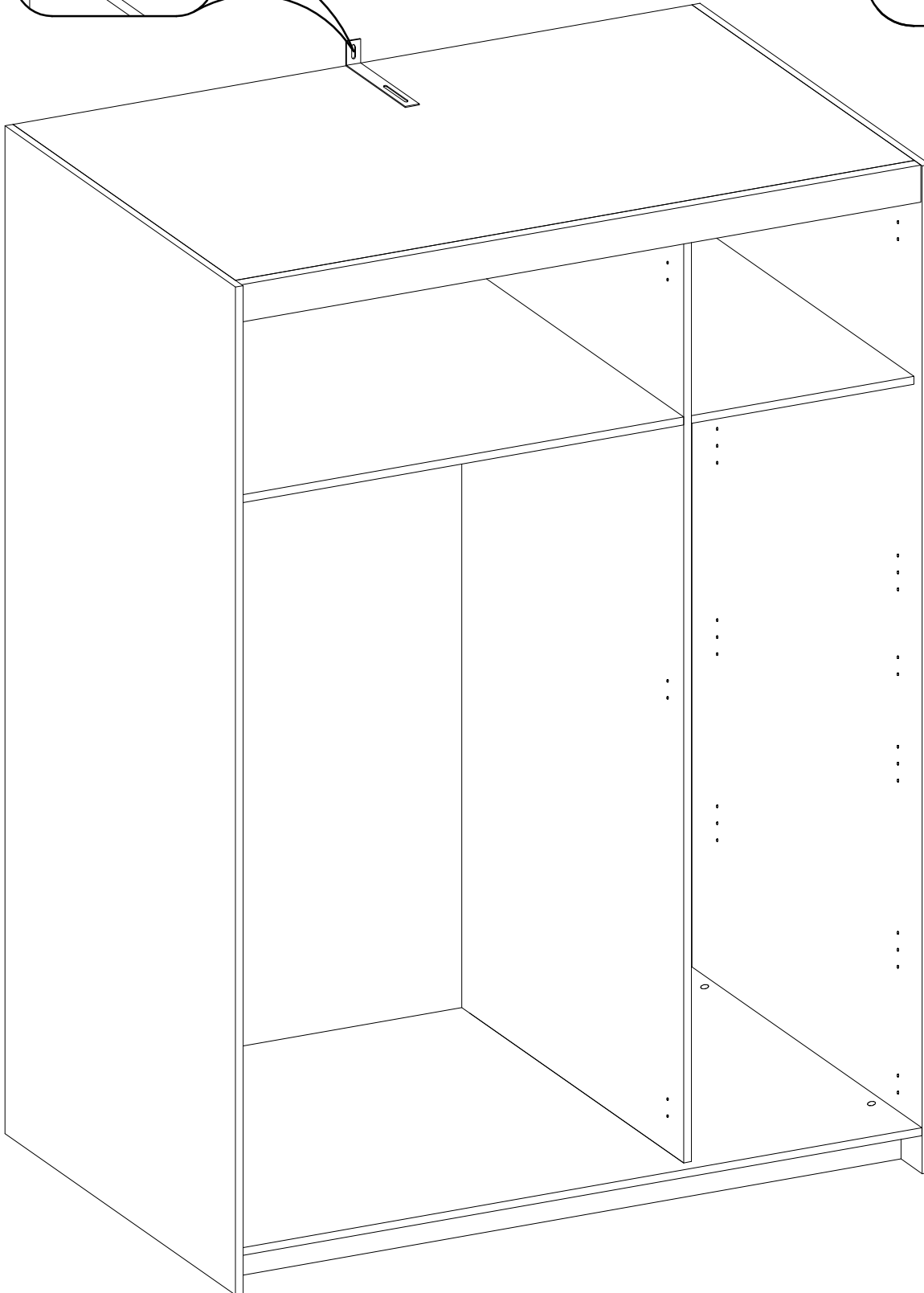
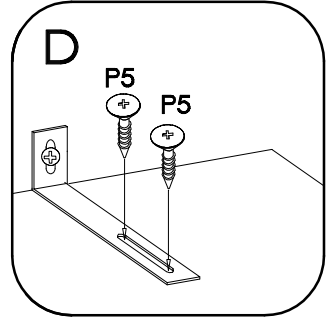
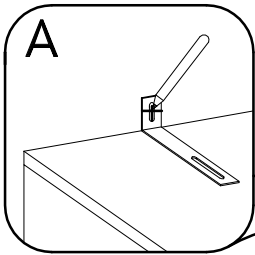

| ±5.0x60mm | ±10x50mm | | ±3.5x13mm |
|-----------|----------|-----|-----------|
| | | | |
| P12 | O7 | L19 | P5 |
| 1 | 1 | 1 | 2 |





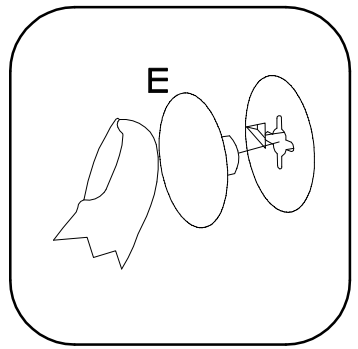
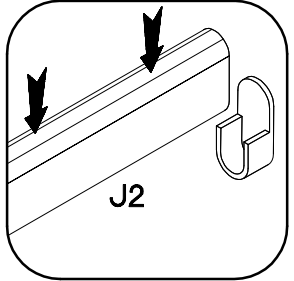
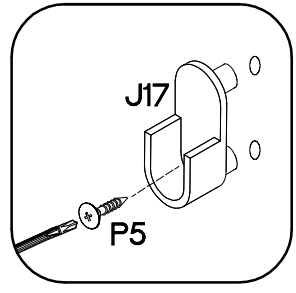
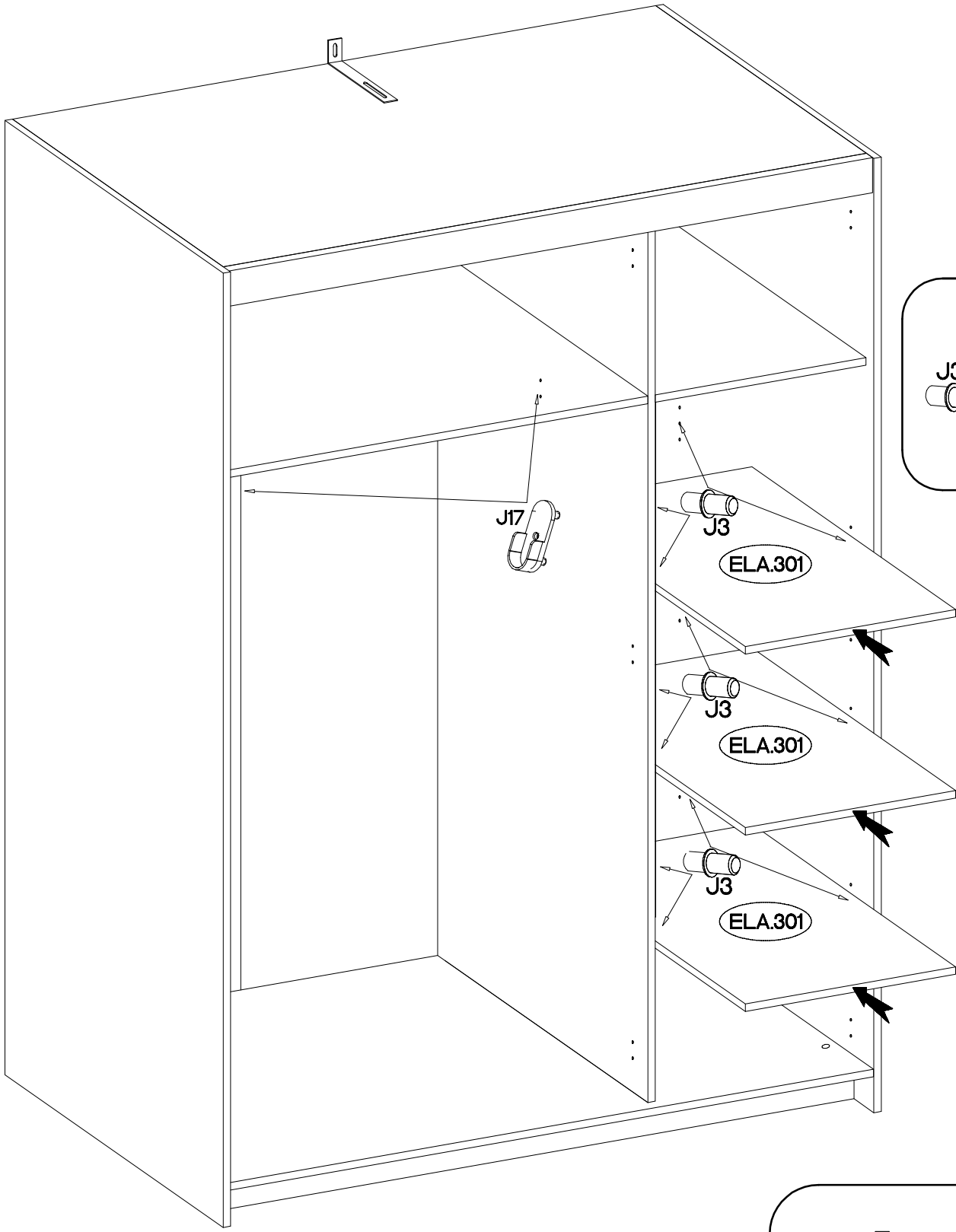

6

| | | | | |
|---|---|--|--|--|
| $\varnothing 3.5 \times 13 \text{mm}$  | L=851mm  |  |  |  |
| P5 | J2 | J17 | J3 | E |
| 2 | 1 | 2 | 12 | 20 |



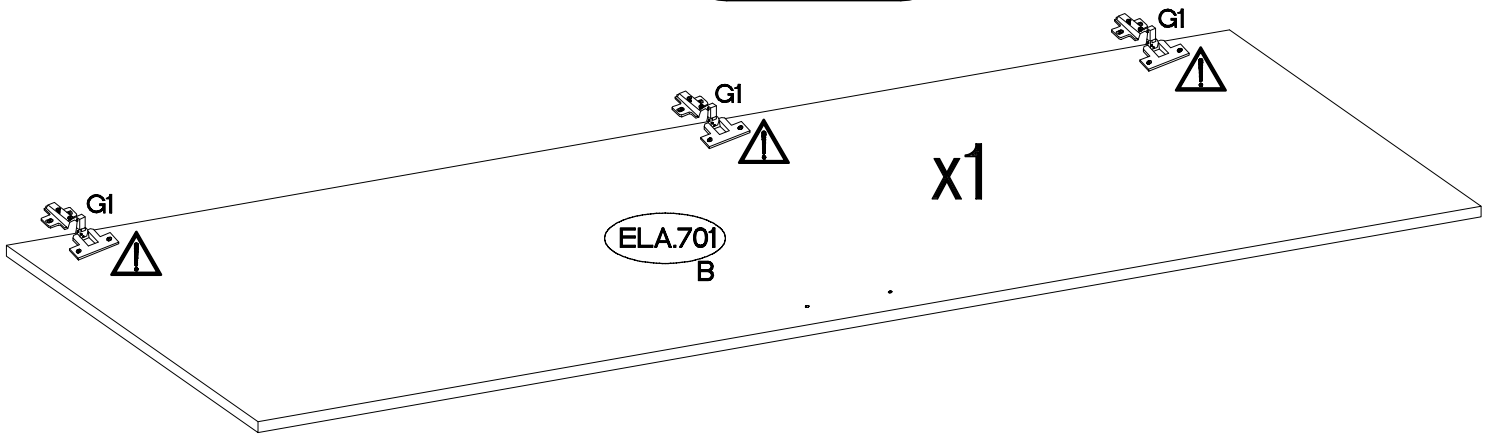
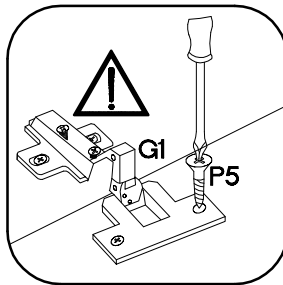
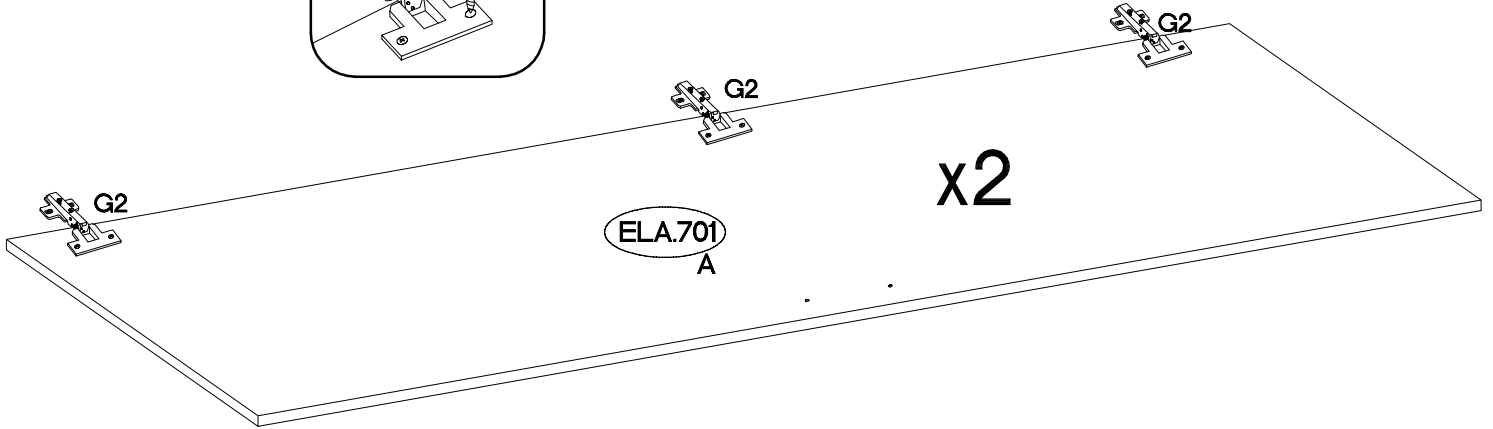
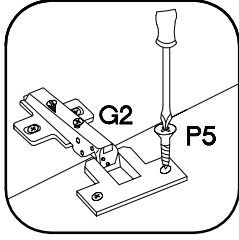
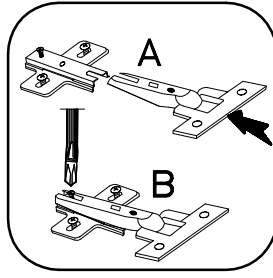

7

| | | | |
|---|---|---|--|
| +35/16mm  G2 6 | H=0  H 9 | +3.5x13mm  P5 18 | +35/9mm  G1 3 |
|---|---|---|--|

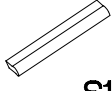

8

| | |
|--|--|
| L=128mm | 4.0x27mm |
|  |  |
| S11 | R1 |
| 3 | 6 |

